



KIT Cable Harness DC-DC

100323, 100323-2.

 Installation and servicing of Danfoss Turbocor® compressors by qualified and product trained personnel only. Follow these instructions and sound refrigeration/electrical/servicing practices relating to installation, commissioning, maintenance and service.			
Consult the appropriate Danfoss Turbocor Compressors Inc. (DTC) Service Manual on turbocoroem.com for detailed service instructions.	<p>Never power compressor without covers in place and secured.</p> <p>Removing the mains input cover will expose you to a voltage hazard of up to 575V. Ensure the mains input power is off and locked out before removing cover.</p> <p>Before removing top cover, wait at least 20 minutes after isolating AC power to allow the high voltage capacitors to discharge.</p>	<p>Always wear appropriately rated safety equipment when working around equipment and/or components energized with high voltage.</p> <p>This equipment contains hazardous voltages that can cause serious injury or death.</p>	<p>Recover all refrigerant from compressor in accordance with local codes and ensure pressure is fully vented before the removal of refrigerant containing components.</p>

1 - Introduction:

CABLE HARNESS DC-DC replacement.

This kit contains the DC-DC Converter Harness. Please refer to our Service Manual for details regarding the replacement of the harness.

We have made the **TTS/TGS/TTH/TGH Service Manual** available to anyone. To access the manual, you may scan the applicable QR code below or you may go to our DTC website at www.turbocoroem.com. At the top of the page there is a pull-down menu called "Quick Links." Click this menu and select the appropriate service manual.

Refer to the applicable QR code below to download the TTS/TGS/TTH/TGH Service Manual.

English



Chinese



There are two (2) variants of the DC-DC Converter mentioned in these instructions. There is a potted style and an open-frame style DC-DC Converter. The open-frame style utilizes three (3) connectors whereas the potted style uses four (4). The open-frame design no longer uses the 15VAC trigger signal from the Soft Start, thus eliminating the need for J4. Refer to the following two figures for proper identification of the two (2) DC-DC Converter styles.

Figure 1 – Open Frame DC-DC Converter

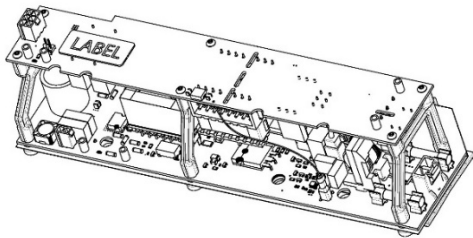
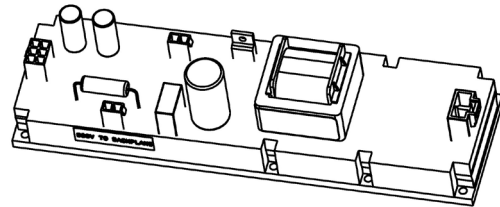

Figure 2 – Potted DC-DC Converter



2 - CABLE HARNESS DC-DC Removal Instructions:

1. Isolate compressor power as described in the Electrical Isolation of the Compressor section of the Service Manual (M-SV-001).
2. Remove the Mains Input Cover by releasing the fasteners that secure the Mains input cover and remove the cover.
3. Release the fasteners that secure the Top Cover and remove the cover.
4. Release the fasteners that secure the Service Cover and remove the cover.
5. Disconnect the Motor Thermistor Connections. Refer to Figure 3 (Motor Thermistor and Soft Start Connectors) for this and the following step.
For F Series and later compressors, disconnect the Soft Start Temperature Harness (J9) from the Soft Start (for 100323-2 only).

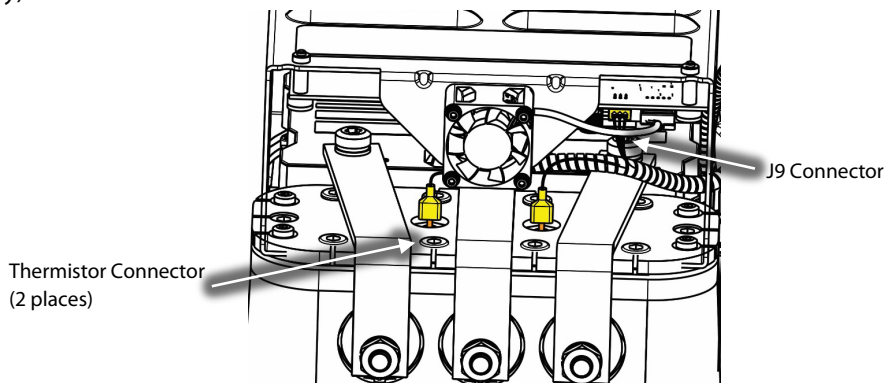

Figure 3 – Motor Thermistor and Soft Start Connectors

6. Disconnect the 24 and 250VDC output from the DC-DC. Refer to Figure 4 (Potted DC-DC Converter) or Figure 5 (Open Frame DC-DC Converter) depending on the installed DC-DC Converter.

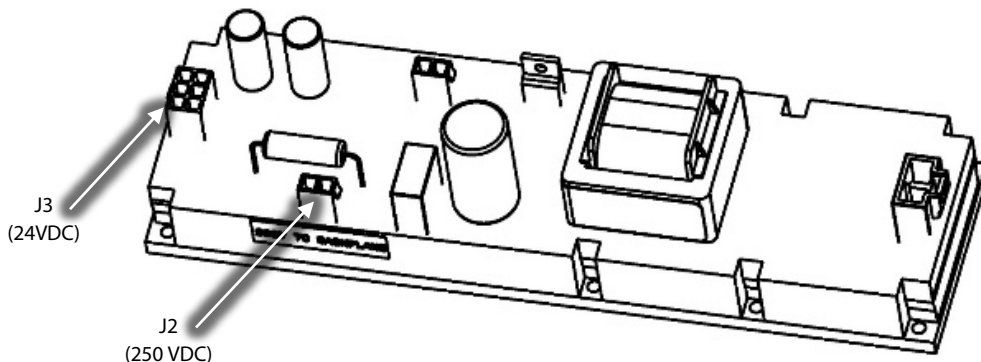

Figure 4 – Potted DC-DC Converter

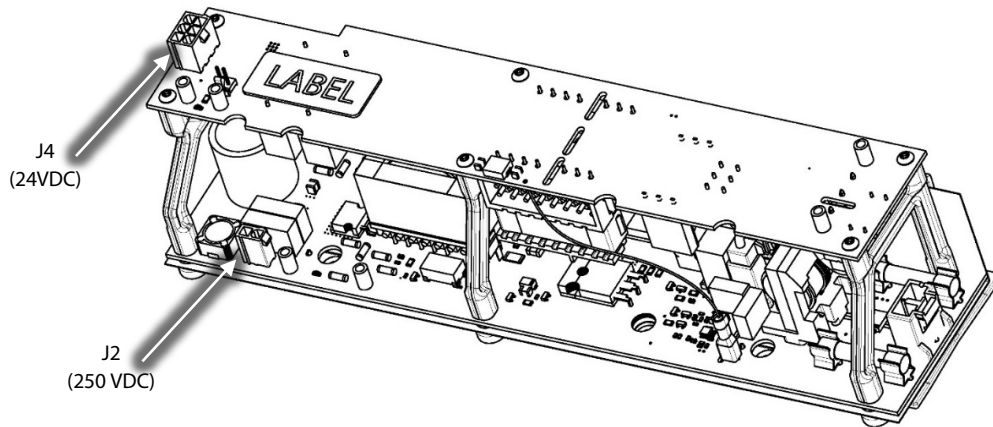

Figure 5 – Open Frame DC-DC Converter

7. Carefully cut any cable ties that may be securing the cable harness in place.
8. Carefully pull the cable harness through the passage down to the service side.
9. Disconnect J4, J20, and J24 from the Backplane. If using kit 100323-2, disconnect J22. Refer to Figure 6 (Backplane Connector Locations).

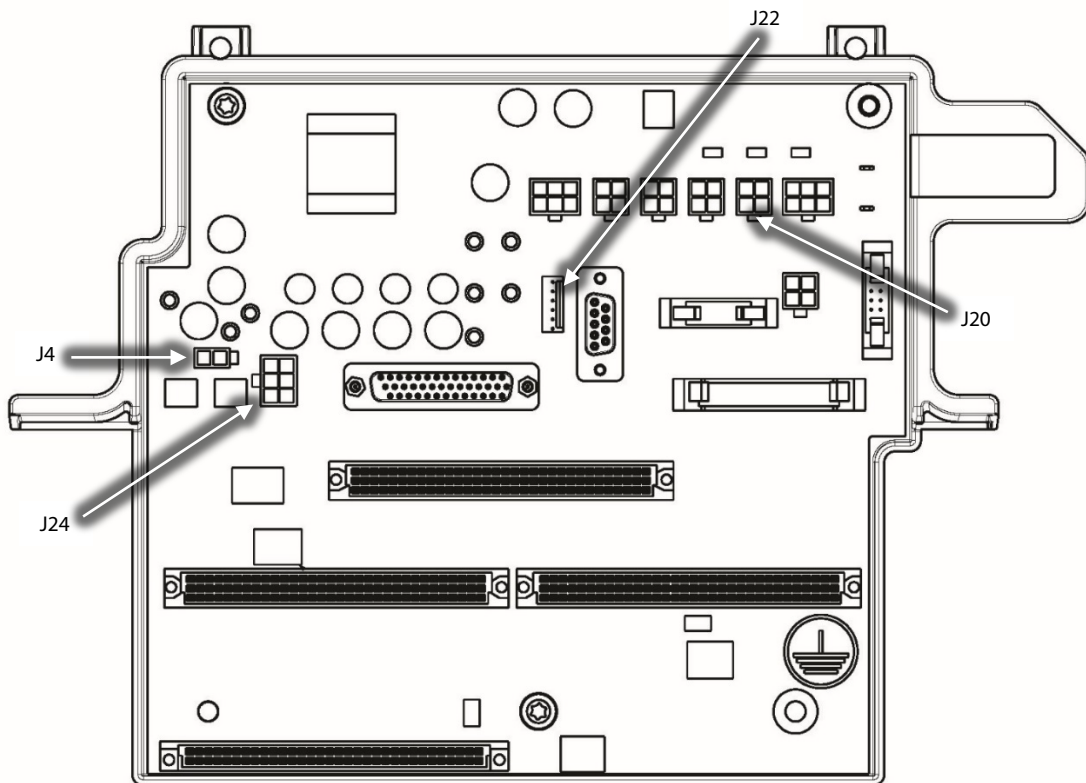

Figure 6 – Backplane Connector Locations

10. Remove the harness.

3 - CABLE HARNESS DC-DC Installation Instructions:

1. Install the new Cable Harness by first feeding the service side portion down the compressor passage from the top. Connect J4, J20, and J24 to the backplane and J22 if using kit 100323-2. Refer to Figure 7 (Cable Passage) and Figure 8 (DC-DC Cable Installed onto Backplane).

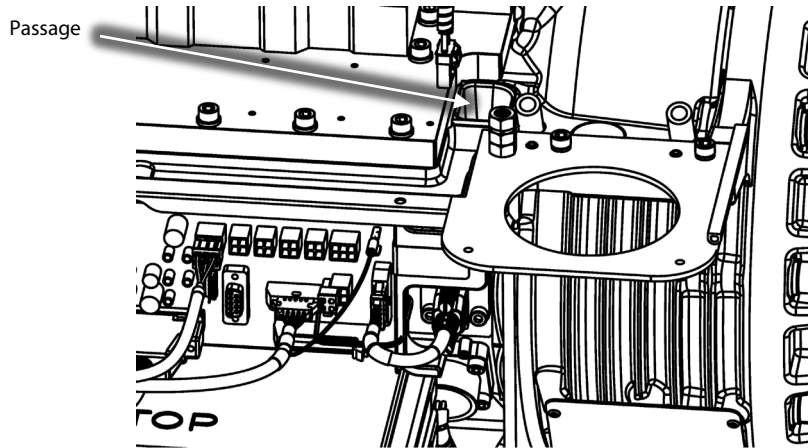

Figure 7 – Cable Passage

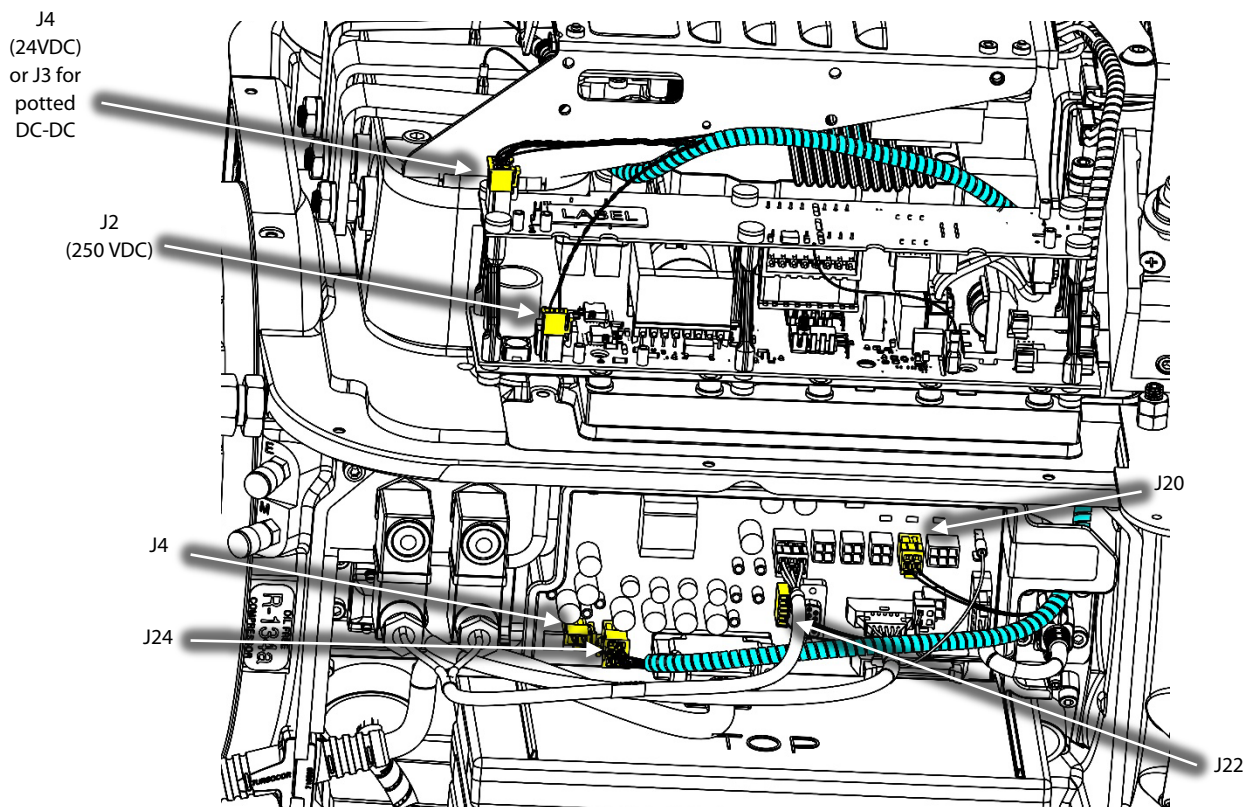

Figure 8 – DC-DC Cable Installed onto Backplane

2. Route and connect the motor thermistor spade connections.
3. Connect the 24 and 250VDC connectors of the harness to the DC-DC.
4. Install cable ties as necessary.
5. If applicable, attach the J9 connector to the Soft Start Board (for 100323-2 only).
6. Ensure that no dirt/debris is on the contact surfaces of the cover and main housing sides.
7. Place the Service Side Cover and secure it with the fasteners according to the following sequence. Refer to Figure 9 (Service Side Cover Install).

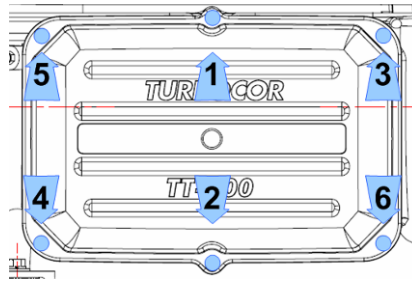

Figure 9 – Service Side Cover Install

8. Follow the sequence twice. The first time, only thread the fasteners to half way down to allow for adjustment. Torque to 13 in.lb. on the second pass.
9. Ensure that no dirt/debris is on the contact surfaces of Top Cover and casting sides.
10. Place the Top Cover and secure it with the fasteners according to the following sequence. Follow the sequence twice. The first time, only thread the fasteners half way down to allow for adjustments. Torque to 13 in.lb. on the second pass. Refer to Figure 10 (Top Cover Install).

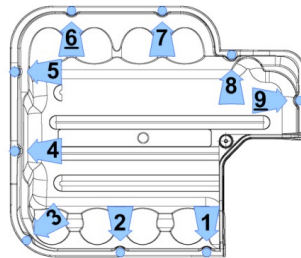

Figure 10 – Top Cover Install

11. Ensure that no dirt/debris is on the contact surfaces of the Mains Input Cover and casting sides.
12. Place the New Mains Input Cover and secure it with the fasteners. Tighten according to the following sequence. Refer to Figure 11 (Mains Input Cover Install).

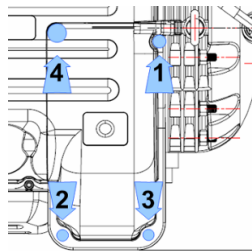
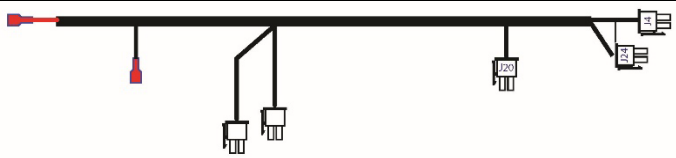



Figure 11 – Mains Input Cover Install

13. Follow the sequence twice. The first time, only thread the fasteners to half way down to allow for adjustment. Torque to 13 in.lb. on the second pass. Fasten the # 4 fastener only once and use caution as to not overtighten this fastener.
14. Reconnect power.

4 - Kit Contents

Kit	100323	
QTY	Part(s) Description	Picture(s)
1	Cable Harness DC-DC	

Kit	100323-2	
QTY	Part(s) Description	Picture(s)
1	Cable Harness DC-DC and SS Temp	

Danfoss can accept no responsibility for possible errors in catalogues, brochures and other printed material. Danfoss reserves the right to alter its products without notice. This also applies to products already on order provided that such alterations can be made without subsequential changes being necessary in specifications already agreed. All trademarks in this material are property of the respective companies. Danfoss and the Danfoss logotype are trademarks of Danfoss A/S. All rights reserved.